

Module 1

Illumination Engineering Basics

Lesson

6

Photometry

Instructional Objectives

- Understand photometric bench
- What is an Illumination Meter
- Understand Light Distribution Curves
- What is a Rousseau Diagram
- Understand a Luminaire.

Photometry

Primary Standard was defined in an earlier lecture based on the brightness of a body (i.e. black body) maintained at Freezing Temperature of platinum. Unit of Luminous Intensity abbreviated as is candela $cd(z)$. Light Flux hence emanating from a point source in all directions is Illuminance - $\frac{1}{4} \pi$ lumens and is termed msli is the light flux incident on a task surface in lumens per unit area and is called lux. Comparison with a standard. Normally Primary standards are kept in standards Laboratories. Usually Incandescent Lamp Compared with a Primary standard is used as a Laboratory Standard. The test source / lamp is compared With the Laboratory Standard. However, Incandescent Lamp not suitable beyond 50 – 100 hours Standardization of Lamp is by voltage rating Current rating and wattage.

These measurements comprise photometry. They employ a Photometric Bench with a photometric head which is an opaque screen. These measurements involve compassing the test lamp with standard lamp

- a. by varying the position of comparison lamp (standard Lamp) Is
- b. by varying the position of the test lamp IT
- c. by varying the position of the screen

Measurement is complete when the bench is balanced. It is balanced when two sides of the screen are equally bright [in a Dark Room] as shown in Fig. 1.

Photometric Bench

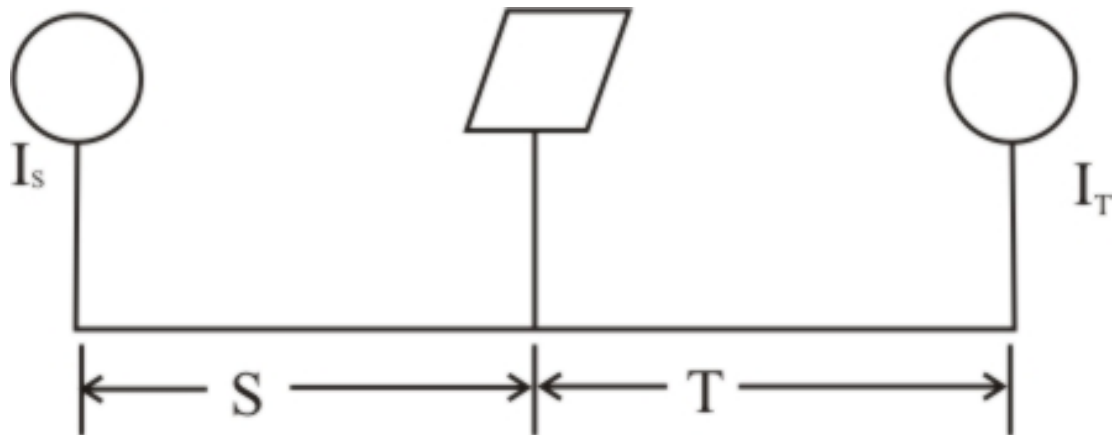

$$\frac{I_s}{S^2} = \frac{I_T}{T^2} \Rightarrow I_T = I_s \frac{T^2}{S^2}$$

Fig. 1 Photometric Bench

Measurements may be made on Illumination meter or Lux meter also in this instead of the screen adjust the meter to get the same reading on photometric bench. Fig 2. shows a method where distance is varied to get the same reading on the meter.

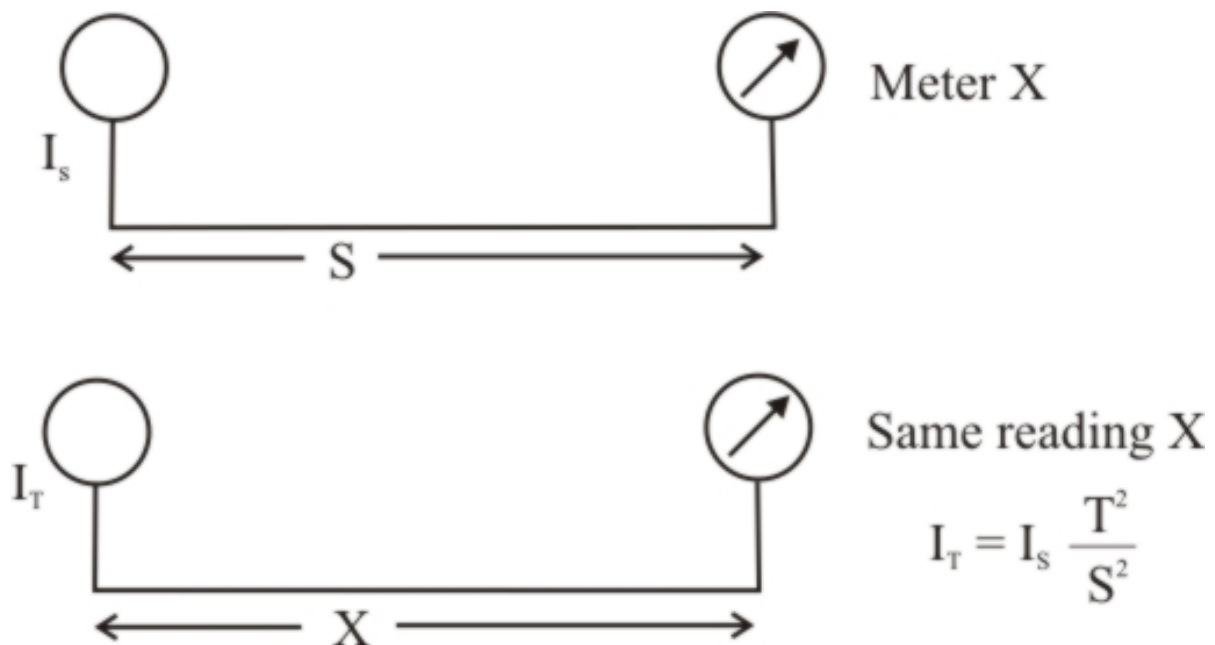

Fig. 2 Use of Lux meter on Photometric Bench

Alternatively, the distance on the bench may be kept constant and readings on the meter are noted.

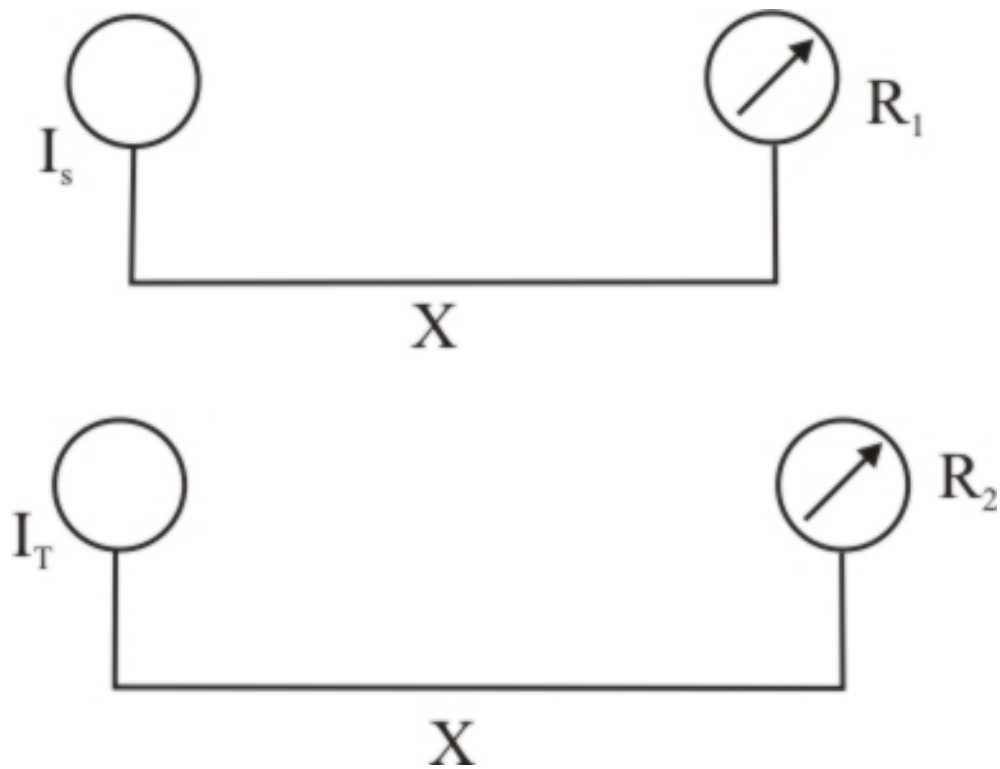

Fig. 3 Photometric Bench with Lux meter at a Constant Distance

Then the intensity of the test Lamp is given by the relation

$$I_T = I_s \times \frac{\text{Reading with Test Lamp}}{\text{Reading with Standard Lamp}} \dots\dots\dots(i)$$

$$I_T = I_s \frac{R_2}{R_1} \dots\dots\dots(ii)$$

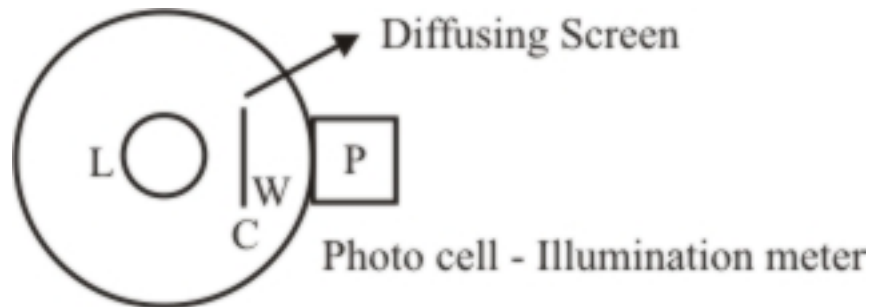

Fig. 4 Integrating Photometer

Fig 4 shows a typical photo meter. It has a standard point source ‘L’ of Light at the centre of a opaque sphere. It has an opening W where a photo cell is placed that receives diffused light from the source. Window ‘W’ is shielded by diffusing screen ‘C’ from direct light. Reading on the micrometer is first taken with a standard Lamp and later with the test Lamp. Then we have

$$\frac{\text{msli of test Lamp}}{\text{msli of standard Lamp}} = \frac{\text{reading with test lamp}}{\text{reading with standard lamp}} \dots\dots\dots (iii)$$

from this, one can obtain light flux output of the test lamp by multiplying msli with 4π .

Fig. 5 shows the photocell employed in a photometer. In a photocell sensitive element 'S' is selenium coated in the form of a thin layer on a steel plate P. This is in turn covered with a thin layer of Metal 'M' on which is a collection ring R.

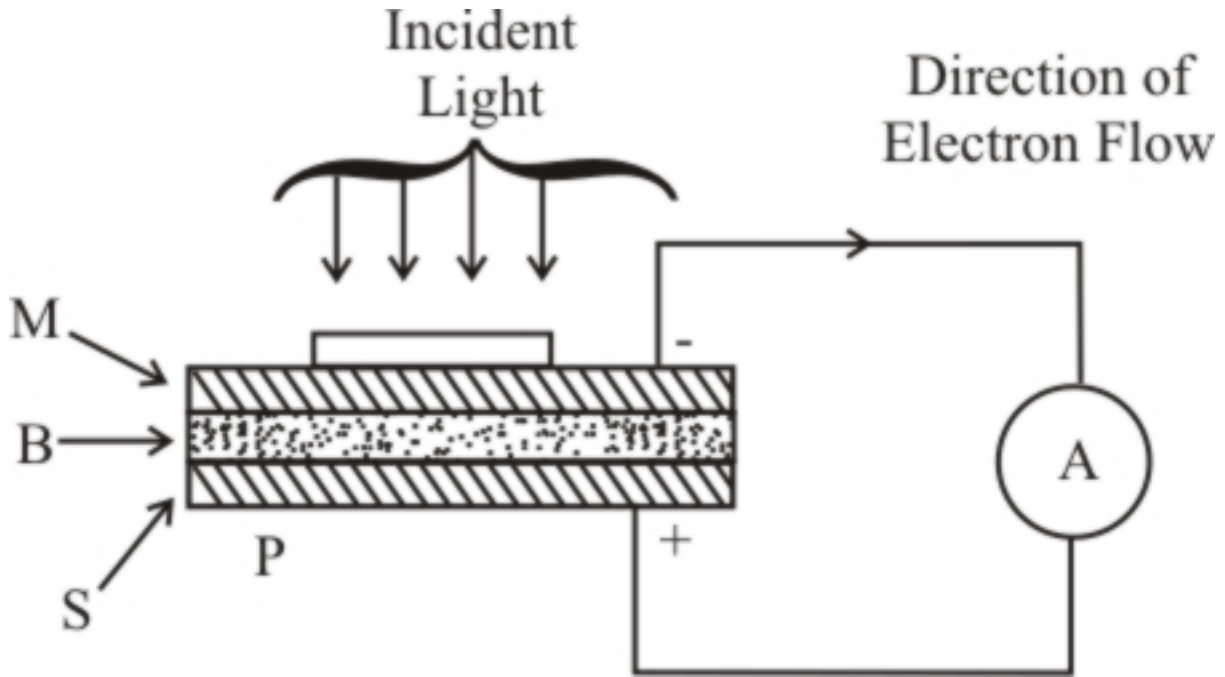

Fig. 5 Photovoltaic cell

Sensitive element is a semi-conductor that releases electrons upon exposure to light. Selenium and Cuprous oxide are most suitable semi-conductor materials. Steel Plate 'P' coated with thin layer of Selenium at 200°C and annealed at 80°C Producing crystalline form. It is in turn coated by a thin transparent film of metal 'M' with a collection ring 'R' of metal.

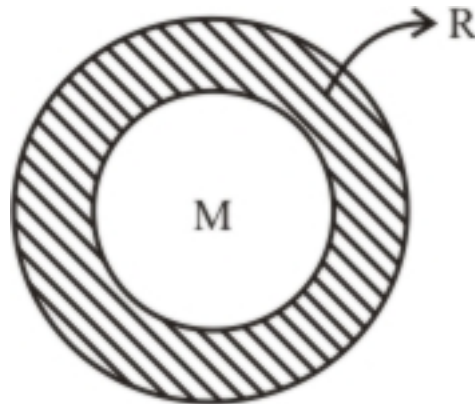

Fig. 6 Top view of a photo cell

B is the barrier Layer Upon exposure to light – light enters through ‘M’ releases electrons from metallic Selenium. They cross barrier ‘B’ to ‘M’ and are collected through ‘R’ and P Current indicated by (A) is proportional to Illuminance. Often (A) is a micro ammeter calibrated in lm.

The next aspect of photometry is to look at the luminance curves of the Lamps. Here comes the role of Luminaries. Luminaries primarily provide the physical support to the Lamps. They may be directing, globes, reflecting or refracting. They could be supported on the walls using wall brackets. They may be portable units on pole mounted in case of street Light. In all cases we need light distribution curves. Light distribution curves are curves giving Variation of Luminous intensity with angle of emission in a Horizontal plane i.e. Polar angle Azimuth or Vertical plane, passing through centre.

Fig 7 shows a typical Polar Luminance distribution curve of a point source of Light. From a Polar Curve in order to arrive at msli of the lamp a Rousseau diagram is constructed. Fig 8 shows such a construction.

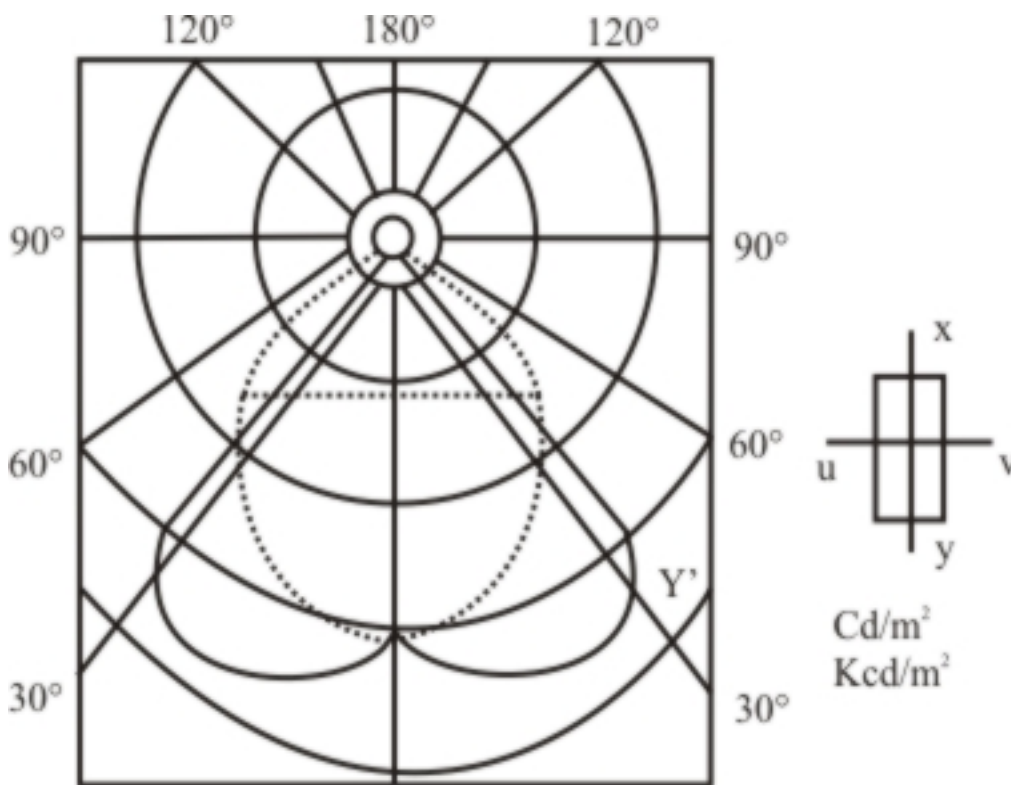

Fig.7 A typical Polar Luminance distribution diagram

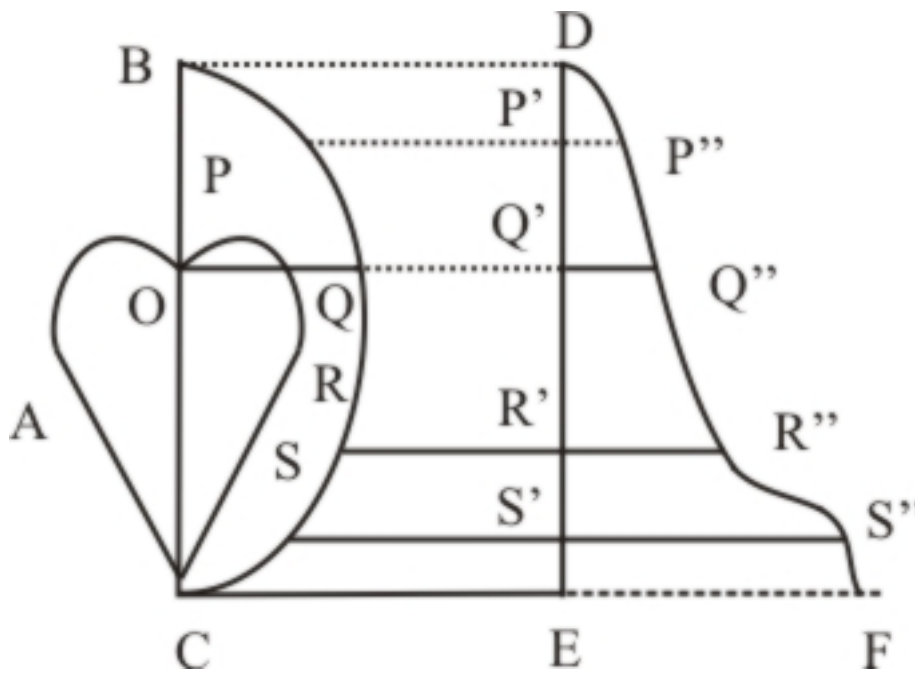

Fig. 8 Rousseau Diagram

Consider the Polar curve A for the typical lamp with O as centre of the Lamp Draw a semicircle of convenient radius $OB = OC$ Insert no. of radii. From the top of there radial segments. From the tip of the radial segments draw horizontal lines extended to cut the vertical line to scale depending on length of Radic. Then the average width of the curve DP “Q” R “S” F is msli.

Luminaire

They Provide Support and electrical connection to the lamp. They are used to control and direct the light and distribute as required. They help to keep the operating temperature within prescribed limits. Using Rousseau diagram, graphical techniques are employed to obtain the MSLL. They should be easy to install and maintain and have a pleasing appearance. They are expected to be economically viable. Thus Requirements for good luminaries may be listed as

- i. to provide support & electrical connection to the lamp
- ii. to control, direct & distribute light as required
- iii. to keep operating temp. within prescribed limits
- iv. should be easy to install & maintain
- v. should have aesthetically pleasing appearance and
- vi. be economically viable

In them Lens & prisms can be used for focusing the light one has to keep in mind Depreciation which is often used as Maintenance factor varies from 0.85 – 0.6. This lesson had a look at the ways of measuring light output of a Lamp. They consisted using photometric bench, either by comparison or reading on an illumination meter. Luminaries which form integral part of Illumination system are characterized by polar luminance curves. Way to assess their luminance has also been discussed.

Lecture Summary

Brightness is measured by an illumination meter which is a photoelectric cell comprising of a photo transistor activated by light. Brightness or luminance is the luminous intensity in the direction of interest per unit projected area

- Light output from a source of light is obtained by comparing it with a primary standard (standard lamp)
- Methods of comparing a test lamp with a standard lamp:
 - vary position of standard lamp
 - vary position of test lamp
 - vary position of the screen
- Luminaires are used for directing the light from a source of light in the desired direction
- Types of luminaires:
 - directed reflectors
 - diffusing

Tutorial Questions

- Why can't an incandescent lamp be used as a standard lamp?
- What is utilization factor?
- What is maintenance factor of a luminaire?
- What are the advantages of diffusing type luminaire?

Answer to Questions of previous Lecture

- What is the standard unit of luminous intensity?
Candela (Cd)
- What is MSLI?
Mean Spherical Luminous Intensity. This unit is used as the light flux is radially outwards from a source which may be assumed to be a point.
- What is the standard procedure to measure luminosity?
- Luminosity can be measured by the standard procedure of photometry

Source:[http://www.nptel.ac.in/courses/Webcourse-contents/IIT%20Kharagpur/Illumination%20Engg/Illumination%20%20Engineering/Lesson-06/pdf/L-6\(NKK\)\(IE\)%20\(\(EE\)NPTEL\).pdf](http://www.nptel.ac.in/courses/Webcourse-contents/IIT%20Kharagpur/Illumination%20Engg/Illumination%20%20Engineering/Lesson-06/pdf/L-6(NKK)(IE)%20((EE)NPTEL).pdf)